

KUP Series Panel Plug-in Relay

- AC coils: 5-240VAC, 50/60 Hz.; DC coils 6-110VDC
- Contact arrangements of 1 form X, 1-3 form A and 1-4 form C
- Wide selection of termination and mounting styles
- PC terminals available
- Push-to-test button and indicator lamp options
- Sockets available for panel, DIN rail or PCB mounting
- Class B coil insulation

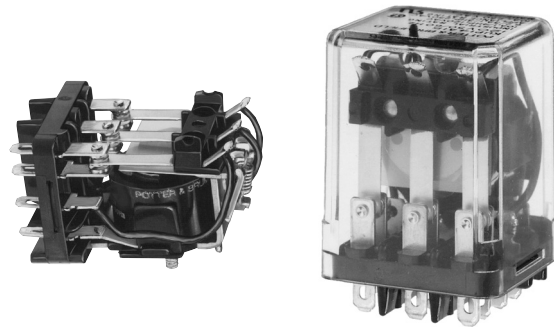

Typical applications

Vending, commercial sewing, tool/die equipment, robotics, timers, welding, HVAC, medical, power generators

Approvals

UL E22575; CSA LR15734
Technical data of approved types on request

Contact Data

Contact arrangement	1 Form X (NO-DM); 1-3 Form A (NO); 1-4 Form C (CO)		
Rated voltage	240VAC		
Rated current	10A		
Contact material	Ag	AgCdO	AgSnOInO
Min. recommended contact load	100mA, 12VDC	300mA, 12VDC	300mA, 12VDC
Frequency of operation	360 ops./hr	360 ops./hr	360 ops./hr
Operate/releases time max.	15/10ms		
Bounce time max.	17ms		

Contact ratings

Type	Load	Cycles
UL 508		
Ag, 1, 2 and 3 pole		
	5A, 240VAC	
	5A, 28VDC	
	1/6HP, 120VAC	
	2.5A, 120VAC, tungsten	
	1/3HP, 240VAC	
	0.5A, 120VDC	
	5FLA, 15LRA, 250VAC	
Ag, 4 pole		
	5A, 240VAC	
	2.5A, 120VAC, tungsten	
	0.5A, 120VDC	
	1/6HP, 120VAC	
	1/3HP, 240VAC	
AgCdO, 1, 2 and 3 pole		
	10A, 240VAC	
	10A, 32VDC	
	5FLA, 15LRA, 250VAC	
	1/3HP, 120VAC	
	5A, 120VAC, tungsten	
	1/2HP, 250VAC	
	0.5A, 125VDC	
	10FLA, 40LRA, 125VAC	
	3A, 600VAC	
	1/2HP, 480VAC	
	1/2HP, 600VAC	
	1HP, 480 VAC, 3 phase	
AgCdO, 4 pole		
	10A, 240VAC	
	5A, 120VAC, tungsten	
	0.5A, 120VDC	
	10A, 28VDC, resistive	
	10FLA, 30LRA, 125VAC	
	5FLA, 15LRA, 250 VAC	30x10 ³
	125VA, 250 VAC	

AgCdO, 4 pole (continued)

1/3HP, 120VAC
1/2HP, 250VAC

Total load not to exceed 30 A, 28 VDC, 120 VAC and 20 A, 250 VAC

AgSnOInO	10A, 277VAC, pf = 0.8	100x10 ³
Mechanical endurance	10x10 ⁶ ops.	

Coil Data

Coil voltage range	5 to 110VDC 6 to 240VAC
Coil insulation system according UL	Class B

Coil versions, DC coil

Coil code	Rated voltage VDC	Operate voltage VDC	Coil resistance Ω±10%	Rated power W
1, 2 and 3 pole				
5	5	3.75	21	1.2
6	6	4.5	32.1	1.125
12	12	9.0	120	1.2
24	24	18.0	472	1.25
48	48	36.0	1800	1.3
110	110	82.5	10000	1.25
4 pole				
5	5	3.75	14	1.8
6	6	4.5	20	1.8
12	12	9.0	80	1.8
24	24	18.0	320	1.8
48	48	36.0	1250	1.85
110	110	82.5	6720	1.8

All figures are given for coil without preenergization, at ambient temperature +23°C.

Coil versions, AC coil

Coil code	Rated voltage VAC	Operate voltage VAC	Coil resistance Ω±15%	Rated power VA
1 and 2 pole				
6	6	5.1	6	2.0
12	12	10.2	24	2.0
24	24	20.4	85	2.0
120	120	102.0	2250	2.1
240	240	204.0	9110	2.1
3 and 4 pole				
6	6	5.1	4.2	2.8
12	12	10.2	18	2.8
24	24	20.4	72	2.8
120	120	102.0	1700	2.9
240	240	204.0	7200	2.9

All figures are given for coil without preenergization, at ambient temperature +23°C.

KUP Series Panel Plug-in Relay (Continued)

Insulation Data

Initial dielectric strength	
between open contacts	1200V _{rms}
between contact and coil	2200V _{rms}
between adjacent contacts	2200V _{rms}
Initial insulation resistance	
between insulated elements	100MΩ, 500VDC

Other Data

Material compliance: EU RoHS/ELV, China RoHS, REACH, Halogen content refer to the Product Compliance Support Center at www.te.com/customersupport/rohssupportcenter.

Ambient temperature

DC coil	Enclosed relays, 4 pole: -45°C to 50°C
	Enclosed relays, 1-3 pole: -45°C to 70°C
	Open relays: 15°C higher maximum
AC coil	Enclosed relays, 3 and 4 pole: -45°C to +45°C
	Enclosed relays, 1 and 2 pole: -45°C to +55°C
	Open relays: 15°C higher maximum

Maximum allowable ambient temperature vs voltage (KUP enclosed)

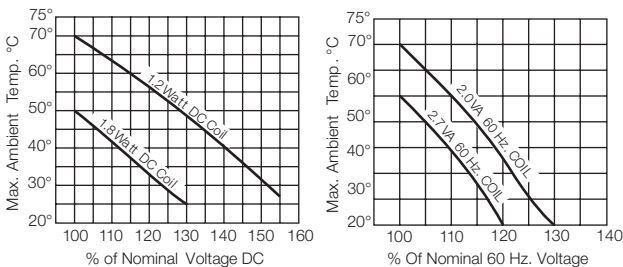

Dimensions

KU bracket type

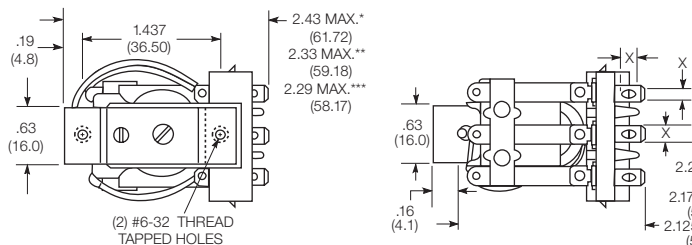

KU stud type

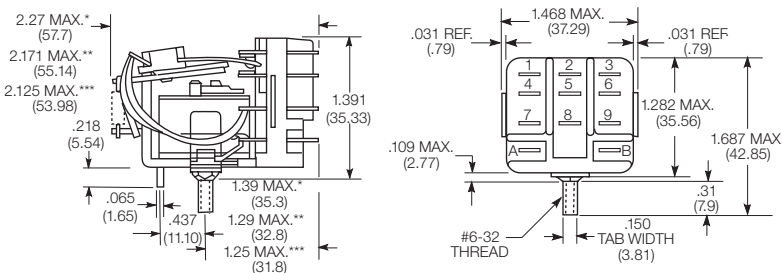

Relay front diagrams

Models with 6.35mm (.250) QC terminals

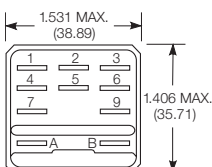

1-3 pole models with all other terminals

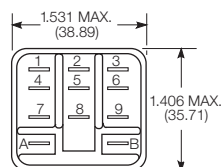

4 pole models

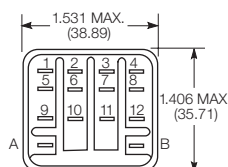

Other Data (continued)

Category of environmental protection	
IEC 61810	RT0 - open relay; RTI - dust protected
Terminal type	
	Quick connects (QC), .187, .205 or .250; PCB-THT
Terminal retention, push force	
QC .205	17 lbs for 3s
QC .187, QC .250, PCB	25 lbs for 3s
Weight	
	85g
Packaging/unit	
	tray/25 pcs., box/150pcs.

Accessories

For details see datasheet Sockets and Accessories, KUP Relays

Product Code	Description
27E893	DIN socket (use 20C318 clip)
27E121	Track mount socket (use 20C314 clips)
27E043	Chassis mount/solder eyelet socket (use 20C254 clip)
27E046	Chassis mount/PCB socket (use 20C254 clip)
27E067	Chassis mount/quick connect socket (use 20C254 clip)
27E396	Snap-in/quick connect socket (use 20C254 clip)

Seated Heights For KU (open) Relays

1.391" (35.33mm) for #6-32 stud with .218" (5.54mm) locating tab.

1.52" (38.6mm) for bracket with 2-#6 32 tapped holes.

1.282" (32.56mm) for #6-32 tapped core with .125" (3.18mm) or .218" (5.54mm) locating tab.

2.046" (51.97mm) for relay with printed circuit terminals.

STUD TYPE also available with .125" (3.18mm) tab, as well as without stud and locating tab. Models without stud have core tapped #6-32 THREAD, .25" (6.4mm) minimum depth.

*Dimensions with .250" (6.35mm) terminals.
** Dimensions with .110" (2.79mm) or .205" (5.21mm) terminals.
*** Dimensions with .187" (4.75mm) terminals.

KUP Series Panel Plug-in Relay (Continued)

Dimensions (continued)

KUP plain case

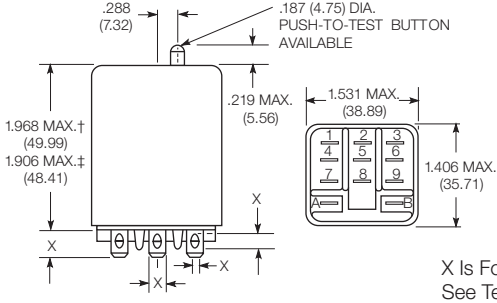

X Is For Terminal Dimensions.
See Terminal Drawings.

KUP core / stud mount case

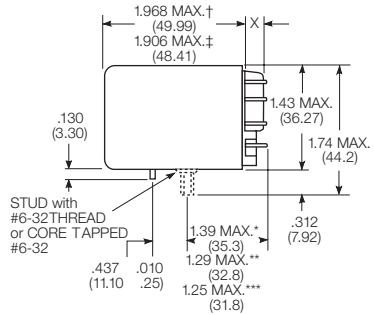

KUP top flange case

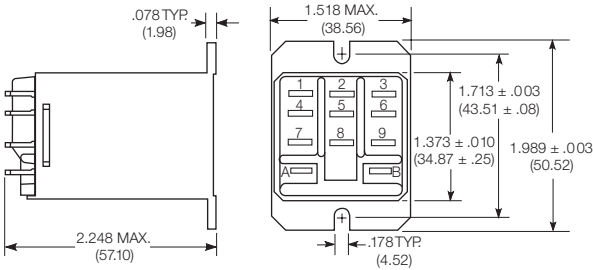

† Dimensions with .250" (6.35mm) terminals.
‡ Dimensions with .187" (4.75mm and .205" 5.21mm) terminals.

*Dimensions with .250" (6.35mm) terminals.
** Dimensions with .110" (2.79mm) or .205" (5.21mm) terminals.
*** Dimensions with .187" (4.75mm) terminals.

KUP bracket mount case

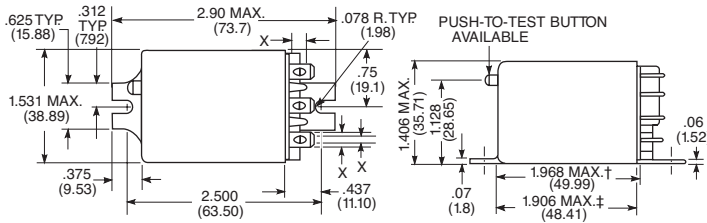

KUP stud on end case

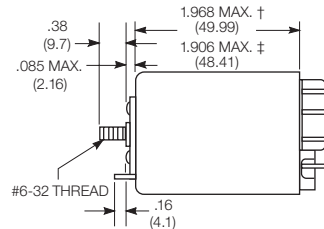

Terminal dimensions

4.75mm (.187) quick connect

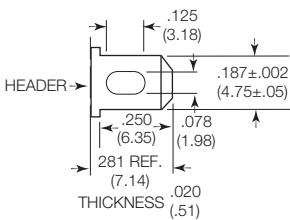

5.21mm (.205) quick connect

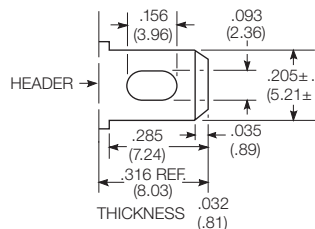

1.19mm (.047) printed circuit

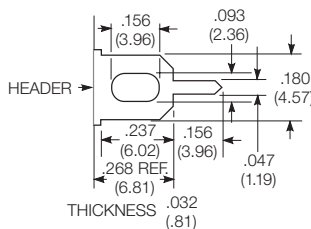

6.35mm (.250) quick connect

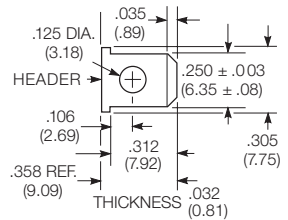

Terminal assignment

1 Form X

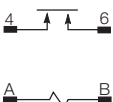

1 Form C

1 Form A (delete 2)

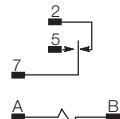

2 Form C

2 Form A (delete 1 & 3)

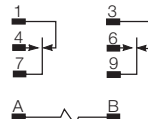

3 Form C

3 Form A (delete 1, 2 & 3)

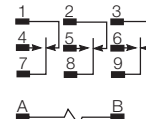

4 Form C

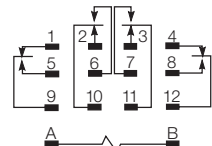

KUP Series Panel Plug-in Relay (Continued)

PCB layout

Bottom view on solder pins

1 form X version

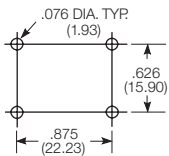

3 pole version
(Omit unnecessary holes for form A and 2 pole types)

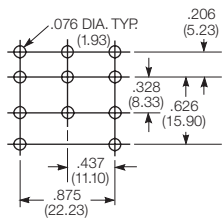

4 pole version

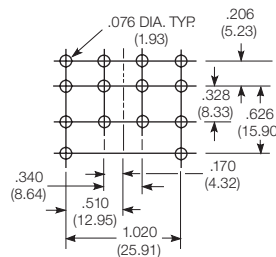

Product code structure

Typical product code **KUP -14 A 1 5 -120**

Type	KUP Enclosed relay	
KU Open style relay		
Contact arrangement		
1 1 form A (1 NO)	3 1 form X (1 NO-DM)	5 1 form C (1 CO)
7 2 form A (2 NO)	11 2 form C (2 CO)	12 3 form A (3 NO)
14 3 form C (3 CO)	17 4 form C (4 CO)	
Coil Input		
A AC, 50/60Hz	D DC	

Mounting and options

KU

- 1** #6-32 mounting stud, 5.54mm (.218in) locating tab
- 3** #6-32 tapped core, 3.18mm (.125in) locating tab
- 4** #6-32 tapped core, 5.54mm (.218in) locating tab
- 5** #6-32 tapped core, no locating tab

KUP

- 1** Socket mount (plain) case
- 2** Socket mount (plain) case with push-to-test button 1)
- 3** Socket mount (plain) case with indicator lamp 2)
- 4** Socket mount (plain) case with indicator lamp and push-to-test button 1) 2)
- 5** Bracket mount case
- A** Plain case with #6-32 stud and locating tab
- E** Plain case with #6-32 tapped core and locating tab
- T** Top flange case 1)

1) Not available with four pole models (Contact arrangement 17).

2) Indicator lamps are available on models with the following coils: 6-24VAC and VDC, 110VDC and 120-240VAC. Only models with 120-240VAC coils are UL recognized.

Terminal and contact material

1 and 2 pole models

- | | |
|--|---|
| 1 4.75mm (.187in) quick connect/solder; Ag, 5A | 3 1.19mm (.047in) PCB; Ag, 5A |
| 5 4.75mm (.187in) quick connect/solder; AgCdO, 10A | 7 1.19mm (.047in) PCB; AgCdO, 10A |
| J 6.35mm (.250in) quick connect/solder; Ag, 5A | K 6.35mm (.250in) quick connect/solder; AgCdO, 10A |
| P 4.75mm (.187in) quick connect/solder; AgSnOInO, 10A | S 1.19mm (.047in) PCB, AgSnOInO; 10A |
| W 6.35mm (.250in) quick connect/solder; AgSnOInO, 10A | |

3 pole models

- | | |
|--|---|
| 1 4.75mm (.187in) quick connect/solder; Ag, 5A | 3 1.19mm (.047in) PCB; Ag, 5A |
| 5 4.75mm (.187in) quick connect/solder; AgCdO, 10A | 7 1.19mm (.047in) PCB; AgCdO, 10A |
| P 4.75mm (.187in) quick connect/solder; AgSnOInO, 10A | S 1.19mm (.047in) PCB, AgSnOInO; 10A |

4 pole models

- | | |
|---|--|
| 1 4.75mm (.187in) quick connect/solder; Ag, 5A 3) | 3 1.19mm (.047in) PCB; Ag, 5A |
| 4 2.79mm (.110in) quick connect/solder; Ag, 5A | 5 4.75mm (.187in) quick connect/solder; AgCdO, 10A 3) |
| 7 1.19mm (.047in) PCB; AgCdO, 10A | 9 2.79mm (.110in) quick connect/solder; AgCdO, 10A |
| P 4.75mm (.187in) quick connect/solder; AgSnOInO, 10A 3) | S 1.19mm (.047in) PCB, AgSnOInO; 10A |
| U 2.79mm (.110in) quick connect/solder; AgSnOInO, 10A 2) | |

3) 4 pole KUP with 4.75mm (.187in) terminals will not plug into sockets. Must use 2.79mm (.110) terminals for socket mounting.

Au flashed contact option

- Leave Blank** No Au flashing on contacts
- F** Optional Au flashing on contacts

Coil voltage

Coil code: please refer to coil versions table

KUP Series Panel Plug-in Relay (Continued)

Product Code	Arrangement	Material	Coil	Terminals	Mounting	Part Number	
KUP-5A15-24	1 form C, 1 CO	AgCdO	24VAC	4.75mm (.187in) QC	Socket mount, plain case	6-1393118-0	
KUP-5A15-120			120VAC				5-1393119-9
KUP-5A15-240			240VAC			6-1393118-1	
KUP-5A55-120			120VAC		Bracket mount case	6-1393118-3	
KUP-5D15-12			12VDC			Socket mount, plain case	6-1393118-6
KUP-5D15-24			24VDC			6-1393118-7	
KUP-5D55-12			12VDC		Bracket mount case	7-1393118-0	
KUP-5D55-24			24VDC				7-1393118-1
KUP-11A11-120	2 form C, 2 CO	Ag	120VAC		4.75mm (.187in) QC	Socket mount, plain case	1-1393117-7
KUP-11A15-12		AgCdO	12VDC				
KUP-11A15-24			24VAC				2-1393117-1
KUP-11A15-120			120VAC				1-1393117-9
KUP-11A15-240			240VAC				2-1393117-2
KUP-11A35-120			120VAC			Socket mount case w/ indicator lamp	2-1393117-5
KUP-11A55-24			24VAC	Bracket mount case			3-1393117-0
KUP-11A55-120			120VAC			2-1393117-9	
KUP-11AT5-120				Top flange case		1-1393117-4	
KUP-11D11-24		Ag	24VDC			Socket mount, plain case	4-1393117-2
KUP-11D15-5		AgCdO	5VDC			4-1393117-8	
KUP-11D15-12			12VDC			4-1393117-4	
KUP-11D15-24			24VDC			4-1393117-5	
KUP-11D15-36			36VDC			4-1393117-6	
KUP-11D15-110			110VDC		4-1393117-3		
KUP-11D35-24			24VDC	Socket mount case w/ indicator lamp	5-1393117-3		
KUP-11D55-6			6VDC		Bracket mount case	6-1393117-0	
KUP-11D55-12			12VDC		5-1393117-6		
KUP-11D55-24			24VDC		5-1393117-8		
KUP-11D55-48			48VDC		5-1393117-9		
KUP-11D55-110			110VDC		5-1393117-5		
KUP-14A11-120	3 form C, 3 CO	Ag	120VAC	4.75mm (.187in) QC	Socket mount, plain case	7-1393117-3	
KUP-14A15-12		AgCdO	12VAC				7-1393117-7
KUP-14A15-24			24VAC			7-1393117-9	
KUP-14A15-120			120VAC			7-1393117-8	
KUP-14A15-240			240VAC			8-1393117-0	
KUP-14A25-120			120VAC		Socket mount w/ test button	8-1393117-3	
KUP-14A35-120						Socket mount w/ indicator lamp	8-1393117-7
KUP-14A35-240			240VAC			8-1393117-9	
KUP-14A35F-120		AgCdO w/ Au flash	120VAC			9-1393117-0	
KUP-14A45-120		AgCdO			Socket mount w/ test button, indicator lamp	9-1393117-4	
KUP-14A55-24			24VAC			Bracket mount case	1393118-2
KUP-14A55-120			120VAC			9-1393117-9	
KUP-14A55-240			240VAC			1393118-3	
KUP-14D11-24		Ag	24VDC		4.75mm (.187in) QC	Socket mount, plain case	1-1393118-0
KUP-14D15-6		AgCdO	6VDC				
KUP-14D15-12			12VDC				1-1393118-3
KUP-14D15-24			24VDC				1-1393118-4
KUP-14D15-48			48VDC				1-1393118-7
KUP-14D15-110			110VDC				1-1393118-2
KUP-14D25-24			24VDC			Socket mount w/ test button	2-1393118-3
KUP-14D35-24							Socket mount w/ indicator lamp
KUP-14D35-110			110VDC				2-1393118-6
KUP-14D35F-110		AgCdO w/ Au flash					2-1393118-9
KUP-14D45-110		AgCdO				Socket mount w/ test button, indicator lamp	3-1393118-1
KUP-14D55-12			12VDC				Bracket mount case
KUP-14D55-24			24VDC				3-1393118-8
KUP-17A19-120	4 form C, 4 CO		120VAC			2.79mm (.110in) QC	Socket mount, plain case
KUP-17A55-24			24VAC		Bracket mount case		
KUP-17D19-24			24VDC		Socket mount, plain case		5-1393118-0
KUP-17D55-24			24VDC				Bracket mount case